

# PAV-Series

## Stereo Portable PA Set

Order ref: 178.859UK 178.869UK

User Manual



Version 1.2



Caution: Please read this manual carefully before operating  
Damage caused by misuse is not covered by the warranty

## Introduction

Thank you for choosing the PAV-series stereo portable PA, which has been designed to provide a complete wire-free sound solution for a wide range of applications. Please read this manual fully to understand the various features on the unit and get the best results from this product.

## Package Contents

Please check the contents to ensure the product has been received in good condition with the following.

- Main portable PA speaker unit
- Satellite speaker with 6.3mm jack connection lead
- 2 x UHF handheld microphones
- I.R. remote control handset
- Power adaptor with appropriate Fig.8 mains lead(s)

If any accessory is missing or the product has any problems, please contact your retailer at once.

## Warning

This product contains no user-serviceable parts so make no attempt to try to fix or modify this item yourself as this will invalidate the warranty. We recommend you keep the original package and proof of purchase for any possible replacement or returned demand. To prevent the risk of fire or electric shock, do not expose this appliance to rain or moisture. To prevent electric shock do not remove the cover. No user serviceable parts inside. Refer servicing to qualified service personnel.

## Safety: Labelling Conventions



**CAUTION**  
RISK OF ELECTRIC SHOCK  
DO NOT OPEN

**AVIS**  
RISQUE DE CHOC ELECTRIQUE  
NE PAS OUVRIR



**This symbol indicates that dangerous voltage constituting a risk of electric shock is present within this unit**



**This symbol indicates that there are important operating and maintenance instructions in the literature accompanying this unit.**

Prior to connecting mains, check the supply voltage is correct and the mains lead is OK.

Avoid ingress of water or particles into the enclosure.

If the mains or D.C. fuse blows, refer the unit to qualified service personnel

## Placement

Keep the unit out of direct sunlight and away from heat sources.

Keep the unit away from moisture or dusty environments.

Mount the unit on a stable surface, 35mm pole mount or suspend using the integral flying points.

Ensure that any supporting structures have adequate load capacity for the weight of the unit.

## Cleaning

Use a soft cloth with a neutral detergent to clean the cabinet, panel and controls. To avoid damage, do not use solvents.

## Main unit rear panel

1. USB port
2. Media player controls
3. CD/DVD disc slot
4. Treble EQ control
5. Echo control
6. Wired mics/guitar volume
7. UHF mic. A volume
8. UHF mic. A+B power & RF LEDs
9. Line output 2 x RCA
10. DC power input jack
11. Power on/off
12. Media player display
13. SD/MMC card slot
14. Bass EQ control
15. Main volume control
16. VCV voice controlled volume on/off
17. Contour tone shaping for UHF mics
18. UHF mic. B volume
19. 6.3mm mic.1/guitar jack input
20. 6.3mm mic.2 jack input
21. 3.5mm stereo Aux input
22. Line input L+R RCA
23. RCA composite video out
24. Battery & power status LEDs
25. 6.3mm satellite speaker out

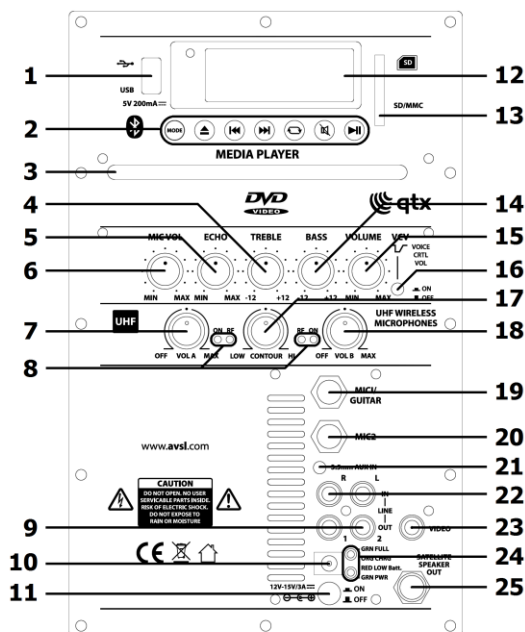

## Portability

For transport purposes, the PAV-series main unit has a retractable handle and wheels. The satellite speaker can be stacked on top of the main unit (ensuring that the feet locate onto the posts at the top of the main unit) and a strap is provided to secure the satellite speaker to the extended handle, allowing the whole set to be rolled as a trolley.

Care should be taken to avoid uneven terrain or dragging the trolley too quickly, which may damage the wheels or cause the set to overbalance.

## Setting up

The PAV-series PA set is based around a main portable PA unit and a satellite speaker. Each can be free standing or mounted onto 35mmØ speaker poles. Open the rear panel on the satellite unit by removing the 4 thumb screws and use the speaker jack lead inside to connect the 6.3mm input on the satellite to the Speaker Out jack (25) on the main unit. The rear cover may then be put back onto the satellite cabinet if required. There is space inside the rear compartment for other accessories, such as microphones, leads and the remote handset.

## Charging the battery and powering up

Your new PAV-series main unit may arrive with you with the internal battery charged. Before connecting to the mains, switch the unit on and see if the power LED (24) lights green and check the adjacent battery charge status LEDs. If the battery charge LED is red (low), you will need to charge the battery before using away from a mains supply.

There is a power adaptor supplied which connects to the main unit via the DC power adaptor inlet (10). This inlet can also be powered from another 12-15Vdc source, such as a car battery.

When connected to the mains via the power adaptor, if the main power on/off button (11) is in the OFF position, the internal battery will be re-charged from the mains supply. This can be observed by the charging LED (above the power LED) which lights orange when charging. When the battery is full, this LED will change to green.

**Note:** it is recommended to store the PA unit at an ambient temperature and not with the battery fully discharged.

To power the main unit up, start with all rotary controls turned down (anti-clockwise) and press the POWER button on (the power LED should light). Turn BASS and TREBLE controls (4, 14) to point vertically (12-o'clock position). Turn up the main Volume (15) control part way and switch VCV (voice controlled volume) off (16). Your PAV-series PA set should now be ready to operate.

Initial checking of the output may be easiest using the internal media player – inserting a disc or USB/SD media normally initiates playback. See the Media Player section further on in this manual for full instructions.

## UHF Wireless Microphones

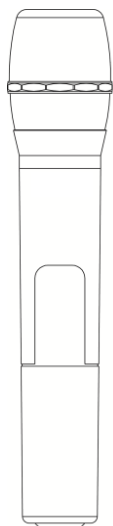

The PAV-series PA has a built-in dual UHF receiver and is supplied with 2 x handheld wireless microphones. Each handheld microphone will need to be loaded with 2 x AA batteries (supplied) before use by carefully unscrewing the base of each and connecting the "+" and "-" terminals of the battery to the corresponding contacts inside the microphone body, taking care to observe the correct polarity.

Turn the UHF VOL A and UHF VOL B controls (7, 18) part way up (clockwise). Antennas are fixed inside the speaker and do not need to be extended.

Switch on each microphone by moving the slide switch upwards. The LED below the switch should light briefly and the RF LEDs on the main unit (8) should also light to indicate that carrier signals are being received.

If the LED on the handheld transmitter lights dimly, it is advised to replace the batteries.

Gradually increase the UHF VOL A and B controls, testing each microphone in turn for output through the speakers.

The UHF microphone volumes are not affected by the main volume control on the rear panel.

Take care not to incur “feedback” (howling or screeching sound through the speaker) by keeping the microphone a sensible distance from each speaker and pointing away from the speakers so that it doesn’t *hear* its own output.

Between the 2 UHF volume controls is a rotary labelled “Contour” (17), which adjusts the mid-focus of the UHF microphones’ tone character. Adjusting from Low to High settings varies the prominence of UHF microphones output in the mix and is best adjusted with experimentation.

Turning the ECHO control (5) clockwise introduces a preset echo for singing and special effects.

If required, the music level can be automatically muted when speaking into a mic by switching the VCV on (16).

When not in use, switch the wireless microphones off and remove the batteries if storing the microphones for long periods.

## **External Inputs**

In addition to the PAV-series PA’s own UHF microphones, two 6.3mm jack inputs (19, 20) are provided for connecting external wired or wireless microphones, which are both governed by the MIC VOL control (6). For guitarists, MIC 1 input can accept a guitar input instead of a mic.

A 3.5mm stereo jack (21) and twin RCA inputs (22) are provided for an Auxiliary line input source such as a CD player or smartphone. The AUX input is governed by the main VOLUME control at the top of the panel.

BASS EQ (14) adjusts the overall low frequency content, which can be cut by turning the control anti-clockwise or boosted by turning the control clockwise.

TREBLE EQ (4) adjusts the overall high frequency content, which can be cut by turning the control anti-clockwise or boosted by turning the control clockwise.

Below the twin RCA input is a twin RCA line output (9) carrying the overall main mix. This can be fed on to further active speakers or portable PA units via a twin RCA lead.

## Media Player

The PAV-series PA has a built-in media player which has different options for media types.

### Disc Player Mode

The media player can play audio CDs (including CD+G) and video DVDs.

Insert a disc into the slot (3) and the mechanism will automatically feed the disc into the player.







If the disc is for video playback, such as DVD or CD+G, connect an RCA video lead from the Video Out connector (23) to a TV or display with composite video input and check that the video is playing correctly.

For DVD playback, there is an on-screen display which can be accessed using the IR remote control (see below). Press the MENU button on the remote control for more in-depth video functions.

### USB/SD/MMC Mode

Alternatively, plug in a USB memory stick containing compressed audio media into the USB port (1) or an SD/MMC card into the SD card slot (13).

For disc or media device playback, there are transport controls below the media player display.

<b>MODE</b>	Select MODE	Switch source between Disc, USB, SD and Bluetooth
	Open/Close	Load disc in or eject disc from the player
	Next/FWD	Select next track
	Previous/REV	Select previous track
	Repeat mode	Select to repeat: All tracks or Single track
	Mute	Mutes output but media continues reading
	Play/Pause	Play or pause the selected track

The media player recognizes the last inserted media device and defaults to playback from this. Media can be switched between using the MODE button.

If playback does not begin automatically, press the Play/Pause button and check for playback through both speakers.

## Bluetooth Wireless Pairing

The final mode for the media player is as a Bluetooth wireless receiver. This allows pairing with a smart phone or tablet for wireless playback of audio from the device.

On the smart phone, check for a device called "PA SYS"

Select this device and opt to connect to it.

Your sending device should state that it is connected to "PA SYS" for audio output.

Play audio on the sending device and check for output through the PAV-series PA speakers.

The PAV-series PA Bluetooth receiver has duplex Play/Pause control over the sending device. Press the transport (Previous, Next, Play/Pause) buttons on the rear panel to control the playback on the sending device. This is useful when the audio is played from a phone in a pocket or on an armband or from a PC or Mac computer.

## Remote Control

The output level of the media player is adjusted via the main Volume control (15)

Alternatively, the media player can be operated using the infra-red remote handset.

This offers some extra functions, which are detailed below.

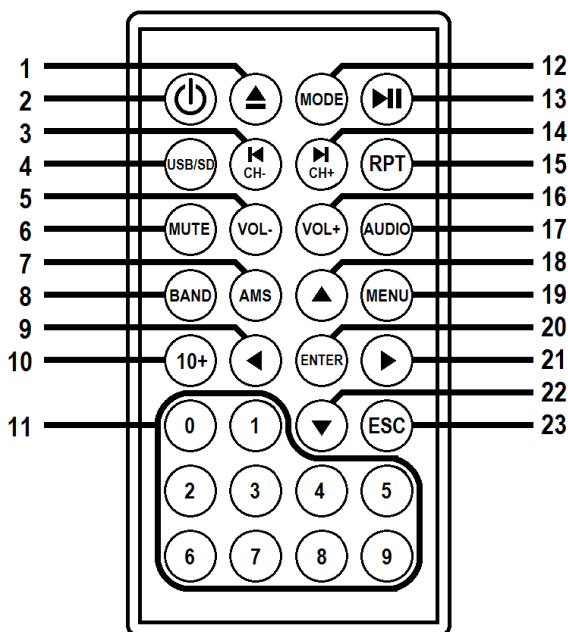

1. Eject
2. Power on/off
3. Previous track
4. Switch between USB/SD media
5. Volume down
6. Mute output
7. \* not used
8. \* not used
9. On-screen display: LEFT key
10. Numerical select: +10
11. Numerical select: 0-9
12. Mode select key
13. Play/Pause
14. Next track
15. Repeat mode
16. Volume up
17. DVD audio output: L, R or L+R
18. On-screen display: UP key
19. On-screen display select
20. On-screen display: ENTER key
21. On-screen display: RIGHT key
22. On-screen display: DOWN key
23. On-screen display: ESCAPE key

## Specifications

Model	PAV8-UHF	PAV10-UHF
Power supply	15Vdc @ 3A mains adaptor (supplied)	
Battery	12V, 4.5Ah	12V, 4.5Ah
Main driver	200mmØ (8") each cabinet	250mmØ (10") each cabinet
Impedance (each speaker)	4Ω	
Amplifier output	50W main unit, 50W satellite	100W main unit, 100W satellite
Controls	Mic Vol, Echo, Treble, Bass, Volume, UHF Vol, Contour, B/T, VCV	
Battery life	Up to 8 hours	
Inputs	2 wired mic (jack) and aux (3.5mm jack or 2 RCA)	
B/T wireless version	3.0	
Carrier frequencies	863.8MHz + 864.8MHz	
Output connections	Composite video, line audio out, satellite speaker output	
Audio source	Media player with CD/DVD, USB/SD/MMC and Bluetooth	
Video format	VCD, DVD, CD+G and mp5 format	
Batteries: handheld mics	2 x AA (each)	
Dimensions	275 x 440 x 290mm (each cab)	520 x 320 x 310mm (each cab)
Weight: satellite speaker	5.50kg	6.18kg
Weight: main unit	8.74kg	9.82kg

## Troubleshooting

No output and no LEDs lit	Check POWER switch is on
	Check battery is not drained fully
	Check mains adaptor is connected and working if battery is flat
Power LED lit but no UHF output	Check batteries in wireless transmitters
	Check wireless transmitters are switched on
	Check UHF VOLUME is not turned down
	Check RF A and RF B LEDs for radio signal
Music level cutting out	Check that VCV is not switched on (will mute upon mic. signal)
Power LED lit but no media player output	Check disc is inserted properly (use eject button if necessary)
	Check disc has correct media type: DVD, CD, CD+G, mp3, mp5, audio
	Check USB has standard compressed audio files on
	Check volume setting on the remote control handset
Power LED lit but no sound from external inputs	Check VOLUME control is not turned down
	Check leads are OK and connected properly
	Check VOLUME or MIC VOLUME control is not fully down



**Disposal:** The "Crossed Wheelie Bin" symbol on the product means that the product is classed as Electrical or Electronic equipment and should not be disposed with other household or commercial waste at the end of its useful life. The goods must be disposed of according to your local council guidelines.

Hereby, AVSL Group Ltd. declares that the radio equipment type 178.859UK and 178.869UK are in compliance with [Directive 2014/53/EU](#)

The full text of the EU declaration of conformity for 178.859UK is available at the following internet address: <http://www.avsl.com/assets/exportdoc/1/7/178859UK%20CE.pdf>

The full text of the EU declaration of conformity for 178.869UK is available at the following internet address: <http://www.avsl.com/assets/exportdoc/1/7/178869UK%20CE.pdf>

*Errors and omissions excepted. Copyright© 2021.*

AVSL Group Ltd. Unit 2-4 Bridgewater Park, Taylor Rd. Manchester. M41 7JQ  
AVSL (EUROPE) Ltd, Unit 3D North Point House, North Point Business Park, New Mallow Road, Cork, Ireland

178.859UK, 178.869UK User Manual