

NUX

B-6 2.4GHz Wireless System for Saxophone



© 2021 Cherub Technology-All rights reserved. No part of this publication may be reproduced in any form without prior written permission of Cherub Technology.

www.nuxefx.com Made in China



NUX B-6, the innovative portable orchestral wireless system, won the iF DESIGN AWARD 2022.
NUX B-6荣获2022年德国iF设计大奖。

WARNING

To reduce the risk of fire or electric shock, do not expose this appliance to rain or moisture.

CAUTION

This device complies with part 15 of the FCC Rules. Operation is subject to the following two conditions: (1) this device may not cause harmful interference, and (2) this device must accept any interference received, including interference that may cause undesired operation. Any changes or modifications not expressly approved by the party responsible for compliance could void the user's authority to operate the equipment.

NOTE: This equipment has been tested and found to comply with the limits for a Class B digital device, pursuant to Part 15 of the FCC Rules. These limits are designed to provide reasonable protection against harmful interference in a residential installation. This equipment generates, uses and can radiate radio frequency energy and, if not installed and used in accordance with the instructions, may cause harmful interference to radio communications. However, there is no guarantee that interference will not occur in a particular installation.

If this equipment does cause harmful interference to radio or television reception, which can be determined by turning the equipment off and on, the user is encouraged to try to correct the interference by one or more of the following measures:

- Reorient or relocate the receiving antenna.
- Increase the separation between the equipment and receiver.
- Connect the equipment into an outlet on a circuit different from that to which the receiver is connected.
- Consult the dealer or an experienced radio/TV technician for help.

The device has been evaluated to meet general RF exposure requirement. The device can be used in portable exposure condition without restriction.



The lightning symbol within a triangle means, "Electrical caution!" It indicates the presence of information about operating voltage and potential risks of electrical shock.



The exclamation point within a triangle means, "Caution!" Please read the information next to all caution signs.

System Overview

NUX B-6 wireless system is designed for saxophone to mic it wirelessly, you can use it with Soprano, Alto and Tenor. B-6 features with automatic setup, 2.4GHz interference-free broadcasting frequency and 24-bit 44.1kHz high quality audio transmitting. The signal latency is super low and less than 4ms. The operation range is around 20 meters (65-feet). B-6 comes with a power case which can store, protect, and charge the wireless units.

B-6 is user-friendly, just turn on transmitter and receiver, and it will be paired within few seconds. Each wireless set has a unique pairing algorithm, it automatically detects each other and configures their own IDs. The signal never interferes with other wireless including the Wi-Fi signal.

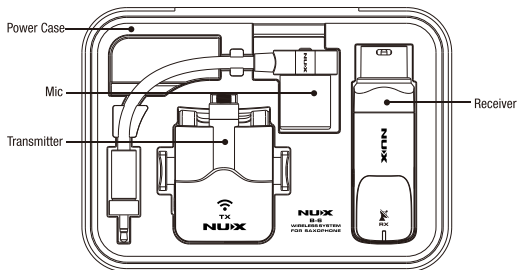

How to Operate

1. INSTALLATION



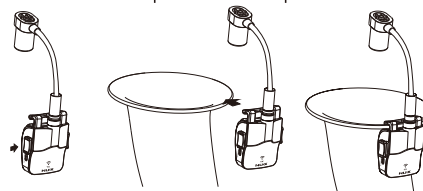

- 1.1 Insert the gooseneck microphone plug firmly into the microphone input jack of the TX until you hear a "pop" sound, and lock the nut tightly.
- 1.2 Press the left and right sides of the TX to open the clip and fix it on the edge of the bell.
- 1.3 Bend down the gooseneck microphone so that the microphone head points towards the center of saxophone bell and keep a moderate distance.

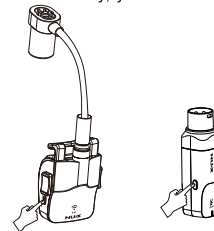

2. TURN ON

- 2.1 Press and hold the POWER/SCENE buttons to turn ON the TX and RX. Before it gets paired automatically, you can see the battery status in 1 second.



- | | |
|---|---|
|  Blinks GREEN | : Well Charged (100% >= Battery >= 75%). |
|  Blinks YELLOW | : Medium Battery (75% > Battery >= 50%). |
|  Blinks RED | : Medium-low Battery (50% > Battery >= 25%). |
|  Flashing RED for 10 times | : Low Battery (<25%), turn off automatically to protect battery life. |

How to Operate

2.2 After 2 seconds, it will be paired automatically, and the receiver's round indicator will flash GREEN.

*B-6 will detect the best channel in 2.4GHz frequency band, if the TX and RX get paired, both will show GREEN. If the RX doesn't receive signal, RX's LED will flash RED. Once the RX receives the signal, it will show GREEN.

3. OPERATE

Connect the RX to the unit you want to send the signal (mixer, audio interface, etc.) . Then, enjoy it.

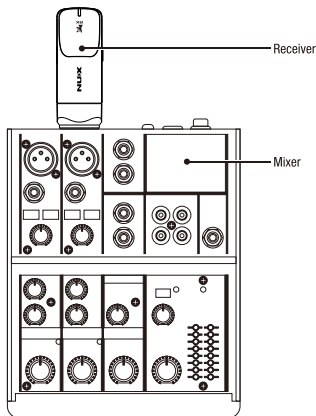

How to Operate

4. STORAGE & CHARGING

4.1 After the performance is finished, press and hold the POWER/SCENE buttons of TX and RX to turn off TX and RX respectively. Press firmly on the left and right sides of TX to open the clip, remove it from the edge of the bell, and remove the gooseneck microphone from the TX. Unplug the RX from the external device. Finally, put all the components back into the power case according to the following figure.

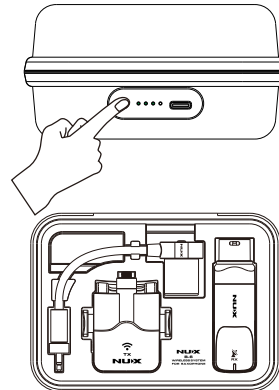

4.2 Use the B-6's power case to charge the B-6. After storing TX & RX according to the above picture, lightly press the power button switch on the side of the power case, and the battery indicator light will light up to indicate the activation of the charging function. After the wireless devices are fully charged, the power case charging function will automatically turn off. When only 1 battery indicator light of the power case lights up, please charge the power case in time.

NOTICE: To charge the power case, please make sure that your power adaptor can deliver output of 5V / 1A(or more).

How to Operate

- 4.3 You can also use the attached Type-C Y-cable to connect with a 5V/1A(or more) adaptor to charge the TX and RX respectively. When charging, the working status indicators of the wireless devices will show a steady red , and the indicators will automatically turn off after charging. B-6 cannot work when charging.

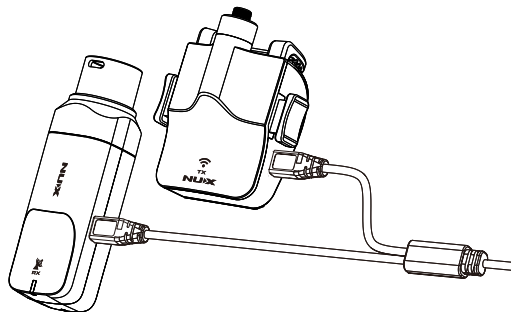

5. RESET ID MATCH

ID Match~ B-6 already sets ID matched before shipping, but if you want to use different TX or RX to get paired, please follow the steps to reset ID match. Turn off the devices, hold the POWER/SCENE buttons on TX and RX for more than 5 seconds, then it will enter to ID match status. When the RX blinks from RED to GREEN, it finishes ID match.



NOTE:

Our product uses Li-polymer battery, before using the product, please charge the battery first. When not using for a long period, charge or activate it in 3 months.

Function Introduction

Scene Function

Because different types of saxophone have different frequency response characteristics, we have set up scene functions for the three commonly used saxophone types. You can select scenes according to the type of saxophone to obtain richer sound expression.

After the B-6 is turned on, under normal working conditions, you can short press the POWER/SCENE button on the TX to switch between different scenes to adapt to the type of saxophone. After the wireless devices are turned on and paired, the working status indicators of TX and RX are steady green. This is the default mode: Alto Saxophone.

 GREEN: Alto Saxophone

 YELLOW: Tenor Saxophone

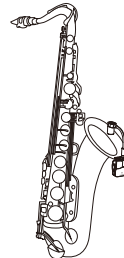
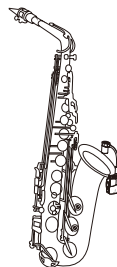

 RED: Soprano Saxophone

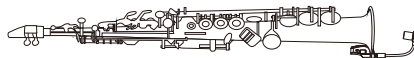

Auto Off Function

If there is no signal for 10 minutes, B-6 TX will turn off automatically to save battery power. When TX is off, after 10 more minutes, RX will also turn off automatically.

Function Introduction

NOTE:

While you are charging the device, B-6 will stop working, and go to battery charging. LED shows RED as charging, while it's fully charged, RED indicator will turn off.

*Recommended: Please stay 2 meters (6 feet) away from the Wi-Fi router for the best performance.

*NUX offers different types of 2.4GHz wireless systems(like guitar wireless, mic wireless, and saxophone wireless), you can use up to 6 systems simultaneously. Please avoid using other wireless systems together with NUX ones, or there may be noise or interference issues.

Specifications

- Frequency Band : 2.4GHz ISM
- Sampling Rate : 24bit/44.1kHz
- Latency : < 4ms
- S/N : 110dB (-A-weighted)
- THD + Noise : <0.2% @1kHz
- TX/RX Battery Run Time: > 4hrs
- Battery Capacity
 - TX/RX Battery Capacity : 500mAh / 3.7V
 - Power Case Battery Capacity : 3000mAh / 3.7V
- Dimensions
 - Power Case : 153mm(L) x 113mm(W) x 55mm(H)
 - TX : 60mm(L) x 53mm(W) x 31mm(H)
 - RX : 80mm(L) x 25mm(W) x 25mm(H)
- Weight : 389g

*Specifications and features are subject to change without notice.

Accessories

- Type-C USB Y cable x 1
- Manual

产品简介

B-6是一款专为萨克斯风设计的无线传输产品。它主要适用于高音(Soprano)、中音(Alto)及次中音(Tenor)萨克斯风,也可用于小号、圆号等其它管乐器上。B-6采用2.4GHz全球公共开放频段,具有自动配对和通道检测功能。其先进的算法保证了在超低延迟的前提下完成24bit/44.1kHz高音质音频的稳定信号传输,有效距离可达20米。B-6配有一个充电收纳盒,可以收纳并保护产品,还可以为产品充电。

B-6体积小、便于安装,可以稳固地夹在萨克斯风管口边缘,且丝毫不会影响演奏体验,顺利地解决了萨克斯风演出收音不便等问题。

产品部件图

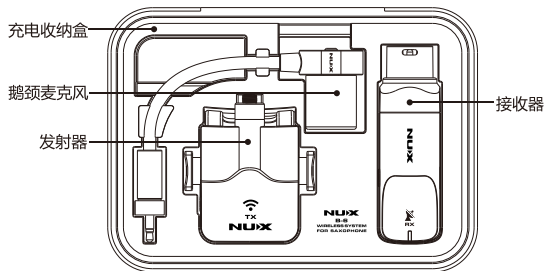

操作指南

安装

1. 将鹅颈麦克风的音频插头用力插入发射器的麦克风插口,直至听到“咔哒”一声后即已插紧,然后将螺帽拧紧。
2. 按压发射器左右两侧的“耳朵”使橡胶夹打开,将其固定于萨克斯风管口的边缘。
3. 弯下鹅颈麦克风,使咪头指向萨克斯风的喇叭口,并保持适中距离。

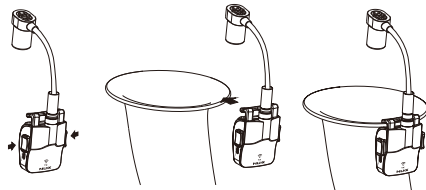

开机

1. 长按发射器与接收器的电源/场景 (POWER/SCENE) 键,分别开启发射器与接收器。开机后(配对未完成时)您可依据本机的工作状态指示灯来估算电池剩余电量。

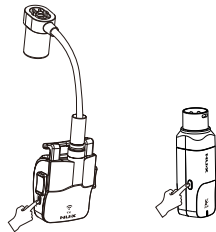

- 绿色灯闪烁 : 100% ≥ 电池电量 ≥ 75%
- 黄色灯闪烁 : 75% > 电池电量 ≥ 50%
- 红色灯闪烁 : 50% > 电池电量 ≥ 25%
- 红色灯持续闪烁 : 电池电量 < 25%, 即将自动关机, 请立即为本机充电。

操作指南

2. 电量显示过后，接收器的工作状态指示灯会呈红色持续闪烁状态，即开始配对。配对时间约2秒钟，配对成功后发射器与接收器的工作状态指示灯均保持绿色常亮状态。

使用

将发射器在萨克斯风的喇叭口或其它乐器上固定好后，将接收器插入音箱、调音台或声卡的卡侬接口后即可开始使用。

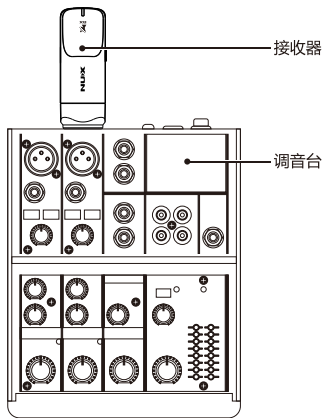

操作指南

收纳及充电

1. 演奏完毕后，长按发射器与接收器的电源/场景 (POWER/SCENE) 键，分别关闭发射器与接收器，用力按压发射器左右两侧的“耳朵”打开橡胶夹子，将其从萨克斯风管口边缘取下，并将鹅颈麦克风从发射器上卸下，将接收器从外部设备上拔下，最后将所有部件按照下图示意装入充电收纳盒。

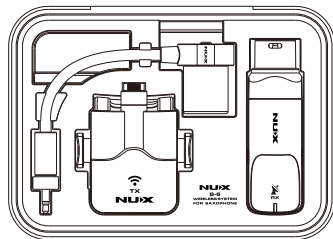

2. 直接使用B-6随机携带的充电收纳盒即可为本机充电。将所有部件按照上图所示装入充电收纳盒后，轻按充电收纳盒侧面的电源按钮，当按钮旁的电量提示灯亮起时表明充电功能已被激活。本机电池电量充满后，充电收纳盒的充电功能会自动关闭。当充电收纳盒的电量提示灯仅剩一格时，请及时为充电收纳盒充电。

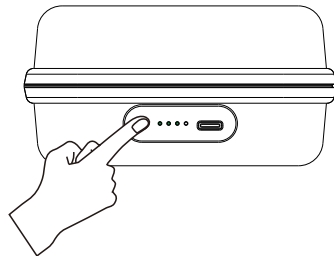

- 3.您还可以使用附赠的双头Type C充电线分别连接发射器与接收器，然后再与输出电压5V、电流大于1A的充电器连接，即可为本机充电。充电时，本机上的工作状态指示灯会呈红色常亮状态，充电结束后指示灯会自动熄灭。充电时B-6无法正常工作。

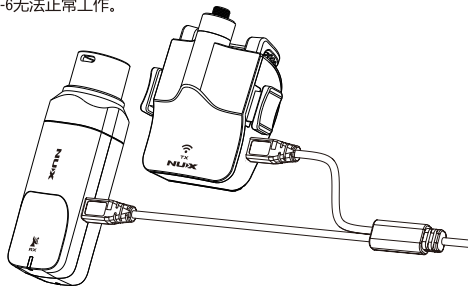

配频ID重置

所有成套出售的B-6在出厂前已经设定好唯一加密配频ID，如果您拥有一套以上B-6，并且想要混合搭配使用时（亦或另购了发射器或接收器），您需要重置加密配频ID。

在发射器与接收器均关闭的状态下同时长按发射器与接收器的电源/场景（POWER/SCENE）键8秒后，发射器与接收器的工作状态指示灯呈绿色常亮，即已完成重置。

场景功能

因为不同类型的萨克斯风频响特性不同，我们针对常用的三种萨克斯风设置了场景功能，您可以按照您萨克斯风的类型进行场景选择，也可以按照您手里其它管乐器的特性，选择频响相近的场景模式，以获得更丰富的音色表现力。

B-6开机后，在正常工作状态下，您可以短按发射器的电源/场景（POWER/SCENE）键以切换不同的音色场景来适配您萨克斯风的类型。本机正常开机并配对后，发射器与接收器的工作状态指示灯呈绿色常亮状态，此时为开机默认模式——中音萨克斯风模式（Alto Saxophone）。

 绿色灯常亮：中音萨克斯风场景
(Alto Saxophone)

 黄色灯常亮：次中音萨克斯风场景
(Tenor Saxophone)

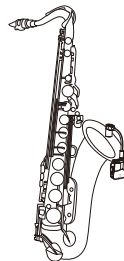
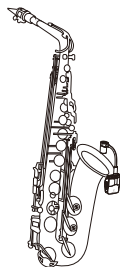

 红色灯常亮：高音萨克斯风场景(Soprano Saxophone)

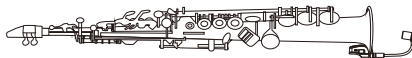

操作指南

自动关机

如果发射器在十分钟内无有效信号输入将自动关机，以延长电池使用寿命。发射器关闭十分钟后，接收器也将自动关机。

▲注意：

- 1.由于无线路由器 (Wi-Fi) 的发射功率普遍较大，使用B-6时请至少与其保持2米以上的距离。
- 2.为了满足不同乐手的需求，我们开发了不同乐器使用的多款2.4GHz无线传输产品，同一空间内最多可同时使用6对无线传输产品。为了避免出现噪声及串扰问题，请尽量避免将其它品牌的无线传输产品与NUX无线传输产品一起使用。

技术规格

- 工作频率：2.4GHz
- 采样精度：24bit
- 采样频率：44.1kHz
- 系统延时：<4ms
- 信噪比：110dB (-A加权)
- 信号失真度：<0.2% @1kHz
- 发射器/接收器电池使用时长：>4hrs
- 发射器/接收器电池容量：500mAh / 3.7V
- 充电收纳盒电池容量：3000mAh / 3.7V
- 尺寸
- 充电收纳盒：153mm(L) x 113mm(W) x 55mm(H)
- 发射器：60mm(L) x 53mm(W) x 31mm(H)
- 接收器：80mm(L) x 25mm(W) x 25mm(H)
- 重量：389g

*技术规格如有变更，恕不另行通知。

随机附件：●Y形充电线1根 ●使用说明书

合格证

检验员

名称 萨克斯风无线系统

生产日期

型号 B-6

本产品经检验合格
执行标准: Q/WKZD 001-2020

有关产品中所含有害物质的说明

为了控制和减少电器电子产品废弃后对环境造成的污染，本资料就本公司产品中所含的特定有害物质及其安全性予以说明。

本资料适用于2016年7月1号以后本公司所制造的产品。

环保使用期限



此标志适用于在中国国内销售的电子信息产品，表示环保使用期限的年限。所谓环保使用期限是指在制造日起的规定期限内，产品中所含的有害物质不致引起环境污染，不会对人身、财产造成严重的不良影响。环保使用期限仅在遵照产品使用说明，正确使用产品的条件下才有效。不当的使用，将会导致有害物质泄漏的危险。

产品中有害物质的名称及含量

部件名称	有害物质					
	铅 (Pb)	汞 (Hg)	镉 (Cd)	六价铬 (Cr(VI))	多溴联苯 (PBB)	多溴二苯醚 (PBDE)
主体	塑胶件	○	○	○	○	○
	五金件	×	○	○	○	○
	硅胶件	○	○	○	○	○
	内置电路板	×	○	○	○	○
附件	*交流电源适配器、线缆	×	○	○	○	○

*表示某些产品可能不含有这些项目，上表当中的信息仅在产品含有这些项目时适用。

本表格依据SJ/T 11364的规定编制。

○：表示该有害物质在该部件所有均质材料中的含量均在GB/T 26572规定的限量要求以下。

×：表示该有害物质至少在该部件的某一均质材料中的含量超过GB/T 26572规定的限量要求，因根据现有的技术水平，还没有什么物质能够代替它。

保护环境

如果需要废弃本产品，请遵循本地相关指引，请勿随意丢弃或作为生活垃圾处理，以避免对环境造成污染。

质量承诺

亲爱的 NUX 用户：

在您使用 NUX 产品时，请您仔细参阅产品说明书，当您有疑问和困难时，请拨打售后服务热线：

400-990-9866

■一周内出现质量问题可退货退款

■一年内出现质量问题可免费维修

■一月内出现质量问题可调换

■终身享有咨询和维修服务

[请向销售商索取正规发票予以保存]

换修政策

一、包换政策：

1. 消费者通过正规授权渠道购买的产品，自购机之日起1个月之内，在正常使用情况下出现非人为的产品性能故障，且产品外观及包装保持完好，可向所购机的经销商换机。

2. 消费者在换机时应出示由经销商开出的购机凭证，否则经销商可以不予更换。

二、保修政策：

1. 消费者通过正规授权渠道购买的产品(以发票所示销售方为准)，自购买之日起1年内，若出现非人为损坏的性能故障，可享受免费维修服务。

2. 对于超过1年或人为及不可抗力因素造成损坏的产品，我司可提供有偿维修服务。

*本售后政策仅适用于中国大陆地区，其它国家及地区以当地售后政策及法律法规为准。

售后服务地址

广东省珠海市高新区唐家湾镇科技九路10号 珠海市蔚科科技开发有限公司 售后服务部 邮编: 519085

制造商: 深圳市蔚科电子科技有限公司 制造商地址: 深圳市南山区蛇口兴华路6号南海意库1楼507

电话: 0755-2686 9866

网址: cn.nuxef.com

生产商: 珠海市蔚科科技开发有限公司

生产商地址: 珠海市高新区唐家湾镇科技九路10号 电话: 0756-3689866 执行标准: Q/WKZD 001-2020